

SERIES:

MGDQ6



tyco Electronics

3003 9th Avenue SW  
PO Box 50  
Watertown, SD 57201  
Toll free: 888-978-2638  
Ph: 605-886-3326  
Fax: 605-886-8995



Low Profile, High Current Power Inductors

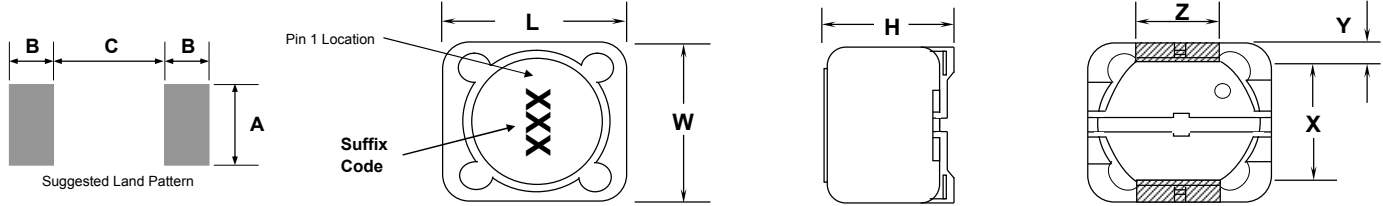

Series Number	Maximum Dimensions				Reference Dimensions					
	Units	L	W	H	X	Y	Z	A	B	C
MGDQ6	inches	0.492"	0.492"	0.315"	0.315"	0.087"	0.197"	0.202"	0.084"	0.307"
	[mm]	[12.50]	[12.50]	[8.00]	[8.00]	[2.20]	[5.00]	[5.13]	[2.13]	[7.80]

Features:

- High energy storage and low resistance
- Reliable surface mounting, flat top for pick and place.
- Smaller real estate than other common inductors.
- Robust temperature deflection to prevent damage during solder reflow.
- Tape and Reel mechanical specifications available upon request.
- Operating Temperature -40°C to +85°C.
- Highly resistive core for EMI suppression applications.

Notes:

- Inductance measured at 100kHz and 250mVrms.
- Isat is a maximum applied AC + DC current.
- Isat current is applied to produce a typical 35% drop in nominal inductance.
- Tolerance suffix of M = ±20%.
- DCR is a maximum at 25°C.



260°C Maximum reflow temperature per J-STD020  
Terminal Plating is Gold Flash over Ni

Schematic Diagram

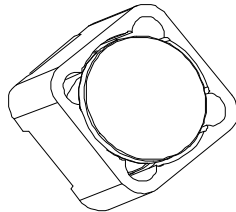
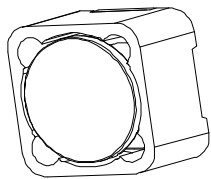
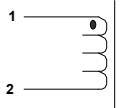

MGDQ6				
Lead Free Part Number	L $\mu$ H	DCR $\Omega$	Isat A	Tolerance Suffix
MGDQ6-00001	0.47	0.0020	35.000	M
MGDQ6-00002	0.75	0.0025	33.000	M
MGDQ6-00003	1.5	0.003	25.000	M
MGDQ6-00004	2.4	0.012	8.000	M
MGDQ6-00005	3.5	0.014	7.500	M
MGDQ6-00006	4.7	0.016	13.500	M
MGDQ6-00007	6.1	0.018	6.600	M
MGDQ6-00008	7.6	0.020	5.900	M
MGDQ6-00009	10	0.022	5.400	M
MGDQ6-00010	12	0.025	4.900	M
MGDQ6-00011	15	0.027	4.500	M
MGDQ6-00012	18	0.040	3.900	M
MGDQ6-00013	22	0.044	3.600	M
MGDQ6-00014	27	0.046	3.400	M
MGDQ6-00015	33	0.065	3.000	M
MGDQ6-00016	39	0.073	2.75	M
MGDQ6-00017	47	0.100	2.500	M
MGDQ6-00018	56	0.110	2.35	M
MGDQ6-00019	68	0.140	2.10	M
MGDQ6-00020	82	0.160	1.95	M
MGDQ6-00021	100	0.220	1.70	M
MGDQ6-00022	120	0.250	1.60	M
MGDQ6-00023	150	0.280	1.42	M
MGDQ6-00024	180	0.350	1.30	M
MGDQ6-00025	220	0.390	1.16	M
MGDQ6-00026	270	0.560	1.06	M
MGDQ6-00027	330	0.640	0.95	M
MGDQ6-00028	390	0.700	0.88	M
MGDQ6-00029	470	0.980	0.79	M
MGDQ6-00030	560	1.070	0.93	M
MGDQ6-00031	680	1.460	0.67	M
MGDQ6-00032	820	1.640	0.60	M
MGDQ6-00033	1000	1.820	0.55	M

Contact CoEv for additional inductance values

Specifications subject to change

Call Toll Free: 888-978-2638 Website: www.tycopowercomponents.com

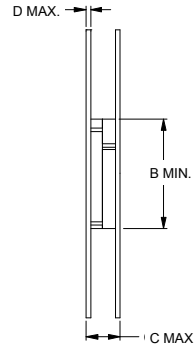
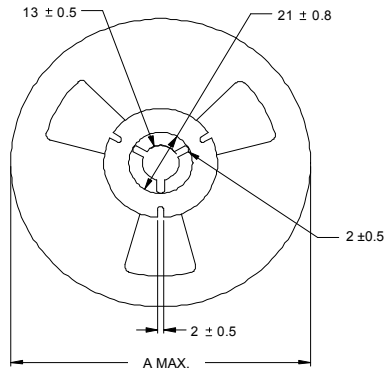

Dimensions are in millimeters unless specified.

Series Number	Reel dimensions				Reel Qty	Carton (Box) Qty	Packaging Specification
	Units	A	B	C			
MGDQ6	in.	12.99"	3.94"	1.16"	0.098"	300	1800
	[mm]	[330]	[100.0]	[29.5]	[2.50]		

PACKAGING NOTE: Only pressure sensitive cover tape is to be used.

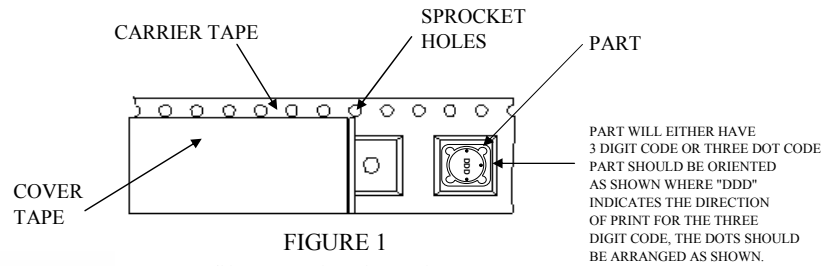
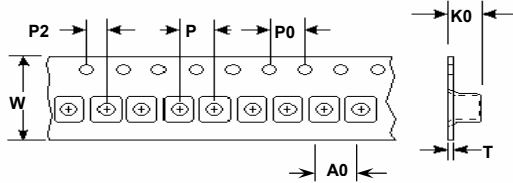

FIGURE 1  
CARRIER TAPE AND PART



Series	W ±0.3	P ±0.1	P0 ±0.1	P2 ±0.1	K0 ±0.05	T ±0.05	A0 ±0.1
MGDQ6	24.0	16.0	4.00	2.00	8.25	0.35	12.6



**Customer Packaging Specifications**  
For Print Distribution to Customers

Series	Revision
MGDQ6	A0
Sheet 2 of 6	

Item	Specification	Test Method/Condition
<b>Environmental</b>		
Static Humidity	After exposure part remains within specified electrical parameters for L, Q and DCR.	Precondition at 25°C for 60 minutes. Expose parts to an environment of +40°C with 90 to 95% R.H. for 240 hours.
Storage Life	After exposure part remains within specified electrical parameters for L, Q and DCR.	Subject parts to an environment of 85°C 85% R.H. for 168 hours. After exposure allow parts to dry for 4 hours before measurements are taken.
Temperature Cycle	After exposure part remains within specified electrical parameters for L, Q and DCR.	10 cycles (Air to Air) 1 cycle shall consist of: 30 minutes exposure to +85°C 30 minutes exposure to -40°C Allow 20 minutes transition between extremes.
Temperature Shock	After exposure part remains within specified electrical parameters for L, Q and DCR.	10 cycles (Air to Air) 1 cycle shall consist of: 30 minutes exposure to -55°C 30 minutes exposure to +125°C 15 seconds maximum transition between temperatures
IR Reflow	10 seconds at 260°C max.	Post test parts shall pass all electrical specifications after reflow. There shall be no visible signs of solder flow or leakage from the part.
<b>General</b>		
Storage Temperature Range	-40°C to +85°C	
Operating Temperature Range	-40°C to +85°C	
Flammability	IEC 695-2-2	Withstands needle-flame test
<b>Other</b>		
Vibration	After exposure part remains within specified electrical parameters for L, Q and DCR.	1 cycle of 30 minutes of the following: 5 - 7 Hz constant displacement of 0.75 inches, 5 minutes 7 - 30 Hz constant acceleration of 1.5 Gs, 10 minutes 31 - 50 Hz constant displacement of 0.33 inches, 5 minutes 50 - 500 Hz constant acceleration of 1.2 Gs, 10 minutes
Mechanical Shock	After exposure part remains within specified electrical parameters for L, Q and DCR.	MGDQ1 Series - 500 Gs per axis, 2 directions MGDQ2 Series - 500 Gs per axis, 2 directions MGDQ3 Series - 500 Gs per axis, 2 directions MGDQ4 Series - 500 Gs per axis, 2 directions MGDQ5 Series - 500 Gs per axis, 2 directions MGDQ6 Series - 500 Gs per axis, 2 directions
Solderability	Wetting shall cover 90% minimum of each termination	Dip pads in RMA flux, 63/37 solder (Sn/Pb) at 232°C for 5 seconds ±2 seconds.
Component Adhesion (Push Test)	Component shall withstand 6 lb. push force minimum without delaminating from mounting surface.	Apply and measure force with a digital force gauge set.
Resistance to Solvent		Withstands 6 minutes of alcohol.  Withstands 3 minutes forced spray Freon TMS
<b>Chemical</b>		
Ionic Contamination	Conductivity: pH: Chlorides: Sodium: Potassium:	11 µOhms/cm maximum 5.5 to 9 65 ppm maximum 20 ppm maximum 10 ppm maximum



**For Print Distribution to Customers**

Series	Revision
<b>MGDQ6</b>	<b>A0</b>
Sheet 3 of 6	